

Trailer Design Guideline

Strenx®: The fastest route to efficient transport.

Contents

Introduction	2
Economic & eco impact of HSS	6
Design	12
Typical upgrading	14
Bending stiffness	16
Stability	16
Fatigue	18
Common pitfalls	19
Manufacturing	24
Edge quality	25
Typical welding methods	25
Future-proof your business	32
Greater trailer capacity	33
Lower lifetime cost	34
Lower carbon footprint	34



Economic & eco
impact of HSS

6

12

Design



Manufacturing

24

32

Future-proof
your business

Introduction

If you are in the trailer business and want to increase payload, reduce maintenance, save fuel, and streamline production while being environmentally responsible, then this document is for you.

Improvements in design and production methods can significantly benefit road transport vehicles like trucks and trailers. Material selection is a key factor that influences the performance and cost of these vehicles. High-strength steels (HSS) like Strenx® performance steel allow for lightweight solutions, directly translating to financial savings and less CO₂ emissions.

HSS makes a natural choice for companies looking to improve their products and to be more competitive. Successful companies using HSS are at the forefront of material, design, and process development while still benefiting from years of experience using conventional steel. By introducing HSS, these companies are gaining new knowledge that they can apply in product design and fabrication.

At SSAB, we help our customers unlock the full potential of our advanced high-strength steels. By choosing Strenx® performance steel, you get more than just high-quality steel. We are happy to share our knowledge with you so that you can select the right steel grade for both design and production.



Economic and environmental aspects of using HSS in the trailer industry

A blue semi-truck is driving on a winding asphalt road that curves through a lush, green forest. The road is bordered by a metal guardrail on the right and a rocky embankment on the left. The scene is captured from an elevated perspective, showing the truck's long trailer and the surrounding natural environment.

Using high-strength steel (HSS) to develop lighter and stronger trailers can have a big impact on the economical performance of the vehicle. It is well known that both trailer manufacturers and transport operators can benefit financially, but the advantages in terms of lower CO₂ emissions should also be recognized.

Benefits for the trailer manufacturer

When looking into the financial benefits for the trailer manufacturer, it is important to consider all aspects that affect the overall production economy. Simply comparing price level per ton for different steel grades fails to provide an accurate picture of the manufacturing cost level. In most cases, reducing the sheet thickness will provide a significant cost reduction in both the processing of the material and material cost. Even if the price per ton is higher for HSS, less steel is consumed thanks to the weight reduction. Using thinner gauges in the workshop allows the cost of cutting, bending and welding to be reduced. Laser-cutting in high-strength steel is no different from cutting in mild steel, and the thinner gauge results in shorter cutting times. In most cases, welding thinner material provides the largest cost savings thanks to the reduction of consumables and the opportunity to increase the welding speed. Introducing HSS with good bendability can also reduce the number of welds needed. Profiles in HSS generally do not require greater force to bend than a profile in a thicker gauge made from conventional steel. However, the spring-back of HSS is greater compared to conventional steel and needs to be compensated for in the process.

To give a better insight into these issues, a comparison between the production costs of a traditional flatbed trailer chassis and a lightweight solution manufactured from HSS was performed. The traditional trailer chassis studied here is manufactured from hot-rolled standardized I-beams, which are cut and welded back together in the goose-neck region to create the height transition of the main beams. The cross-members consist of bent profiles welded to the longitudinal beams and there are also some side-wing profiles to support the floor. The side rail profiles are manufactured from standardized U-beams. All parts are produced from a S355-steel grade. In the lightweight solution the hot-rolled I-beam has been replaced by a laser-cut and welded longitudinal I-beam manufactured from HSS.

Upgrading the traditional chassis by introducing HSS allows for a reduction in the thickness of all major structural parts and in the weight of the chassis by up to 1,500 kg.

In addition to the weight reduction, a production cost reduction of up to 30% can be observed (Figure 1). The costs have decreased for both cutting and welding operations. In this case, a slight increase in the bending cost was observed. Additional bending is required due to design issues, necessitating the introduction of new profile cross-sections. A 30% cost reduction offers obvious benefits for the producer, and when combined with a more attractive lightweight trailer, great market advantages can be expected. It is also noteworthy that this study was conducted on an existing chassis whose structural parts were primarily composed of hot-rolled profiles. If the existing traditional chassis had been produced from welded beams, even greater cost savings could have been achieved.

FIGURE 1

Comparison of production cost of conventional and lightweight trailer chassis including material cost.

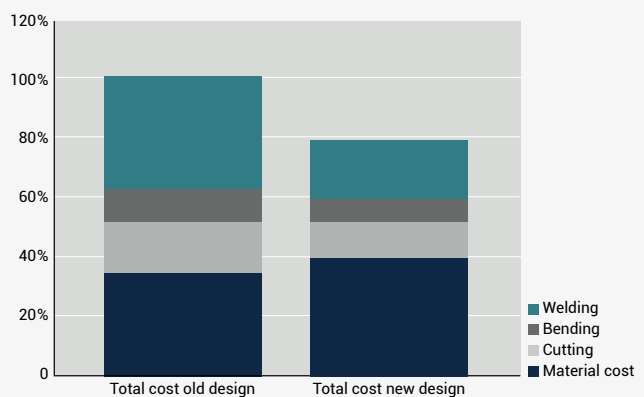

Using thinner material gives cost reductions in both welding and cutting operations. Welding, bending, and cutting costs may vary depending on labor costs in each market.

Benefits for the logistics operator

A lighter and stronger trailer also has a direct and obvious benefit for logistics operators. The maximum weight of the vehicle is limited by law, so a lighter configuration enables an increase in payload on every trip. In many cases, less fuel consumption and resulting fuel savings can also be observed, which directly affects the operational profit of any logistics company. Depending on the type of vehicle and upgrading approach, the introduction of Strenx® performance steel can lower the total weight by 285 to 1,326 kg (628 to 2,923 lbs.). By selecting the appropriate HSS grades for the application, maintenance costs can also be lowered. Combining high-strength with abrasion or weather resistance can also help the vehicles withstand the tough demands on their performance.

Environmental savings

In addition to the financial benefits, a lighter vehicle will reduce environmental impact by saving primary energy resources and reducing greenhouse gas emissions. In a life cycle assessment of a vehicle, different phases are

often analyzed. When comparing an upgraded design to an original design in conventional steel, the influence of steel production and the service life is dominant. The latter often accounts for 90% of the total environmental savings for vehicles.

When analyzing the service life of a vehicle with volume-limited cargo, the energy balance of the vehicle is considered. The basic energy consumption of road vehicles depends on several resistance factors that the vehicle has to overcome during its operation (Figure 2).

All resistance factors, except for aerodynamic resistance, are linearly dependent on mass. The aerodynamic resistance however, depends on the dimensions of the vehicle and the speed. As a result, energy consumption is also affected by mass, speed, acceleration, and gradient (hilly or flat). These factors are highly dependent on the driving situation and driving behavior. Assuming the same driving situation, the correlation between energy consumption and vehicle weight is linear. The energy savings corresponding to a specific weight savings is independent of the absolute weight of the vehicle.

Vehicles with a fast, steady speed will therefore have a high aerodynamic resistance and low acceleration resistance, and thus will have moderate specific energy savings by weight reduction. In contrast, slow vehicles with frequent stops and accelerations will have high energy savings by weight reduction.

FIGURE 2

Overview of resistance factors affecting the fuel consumption of any road vehicle.

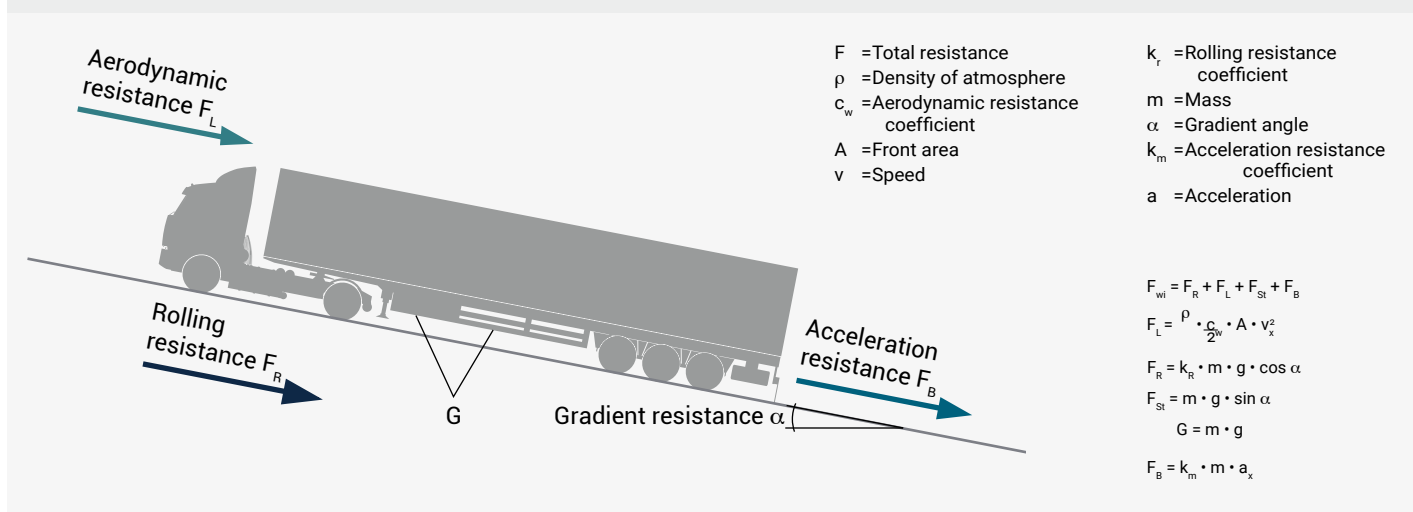



Semi-trailers

Heavy trucks and trailers are the dominant modes of road freight transport in both Europe and the U.S., and account for a significant proportion of the fuel used in the transport sector. Either direct or indirect savings can be achieved by weight reduction. If the cargo is limited by volume, a lighter vehicle uses less energy for hauling, and if the cargo is limited by weight, additional cargo can be transported.

Volume-limited cargo

Let's now consider the impact of weight reductions on lowering fuel consumption, emissions, and raw material input for a tipper (dump) trailer with a gross vehicle weight of 44 tonnes (see Tables 1a and 1b). We assume that the cargo is limited by volume and the vehicles mainly drive on highways and rural main roads. By using Strenx® 700MC instead of S355 steel, you can achieve tare weight savings of 285 kg, a 19% lighter chassis, and annual fuel savings of €589 (around US\$640). This positively impacts emissions, with a lifetime savings of 9.41 tonnes CO₂ gained from less steel produced, longer service life, and greater capacity





with fewer trips. With high-strength steel in thinner dimensions, you can choose to increase legal payload while maintaining the same total weight.

Weight-limited cargo

When hauling weight-limited cargo, reducing the vehicle's weight allows for a higher legal payload, so fewer vehicle-km are needed to transport the same amount of goods. This results in even greater energy savings than for volume-limited cargo. Let's take the example of a heavy flatbed trailer in the tables on pages 6–7. By using Strenx® 700MC instead of hot-rolled S235, you can achieve tare weight savings of 929 kg, a 23% lighter chassis, and annual fuel savings of €2,686 (about US\$2,917). The reduced lifetime CO₂ emissions are substantial, at 62.66 tonnes, considering the reduction in raw material input, longer service life, and greater payload. In our example, the Strenx® chassis brings a total payload revenue increase of €9,461 (about US\$10,278) annually.

TABLE 1 A





Comparison of savings between Strenx® performance steel and other steels, in metric units

					
Chassis case	Light flatbed trailer chassis	Heavy flatbed trailer chassis	Curtain sider trailer chassis	Tipper trailer chassis	Lowbed trailer chassis
Tractor weight (kg)	7 100	8 500	8 100	8 200	9 500
Trailer weight (kg)	6 400	7 400	6 500	6 700	8 500
Total vehicle weight (kg)	13 500	15 900	14 600	14 900	18 000
Maximum payload (kg)	12 500	24 100	25 400	29 100	26 000
Gross vehicle weight (GVW) fully loaded (kg)	26 000	40 000	40 000	44 000	44 000
Current chassis design					
Current material	S355	S235 Hot Rolled	S275	S355	S355 Hot Rolled
Chassi weight (kg)	2 185	4 037	2 554	1 502	4 573
New chassis design					
New design material	Strenx® 700MC	Strenx® 700MC	Strenx® 700MC	Strenx® 700MC	Strenx® 700MC
New design weight (kg)	1 595	2 924	1 941	1 217	3 247
Savings with new design					
Savings (kg)	590	929	613	285	1 326
Savings (%)	27%	23%	24%	19%	29%
Payload data with new design					
Total vehicle weight with new design (kg)	12 910	14 971	13 987	14 615	16 674
Maximum payload with new design (kg)	13 090	25 029	26 013	29 385	27 326
Distance with maximum load (%)	50%	50%	50%	50%	50%
Machine data					
Machine usage per year (km)	100 000	100 000	100 000	70 000	20 000
Lifetime (years)	12	12	12	8	16
Fuel data					
Fuel consumption fully loaded (l/100km)	35	52	48	68	75
Fuel consumption without loaded (l/100km)	22	29	27	28	29
CO₂ lifetime savings					
Lifetime CO ₂ savings from less steel produced (tonnes CO ₂)	1.18	2.23	1.23	0.57	2.65
Lifetime CO ₂ savings from longer service life (tonnes CO ₂)	11.04	19.12	9.12	3.30	11.26
Lifetime CO₂ savings from higher capacity (tonnes CO₂)	28.39	41.32	20.36	5.55	17.47
Lifetime CO ₂ savings total (tonnes CO ₂)	40.62	62.66	30.71	9.41	31.39
CO ₂ payback time (months)	12	14	19	26	43
Lifetime fuel reduction (litres)	13 146	20 146	9 827	2 947	9 578
If also using higher capacity in operation*					
Increased payload revenue (EUR/year)	5 015	9 461	5 210	1 698	2 254
Fuel savings (EUR/year)	1 753	2 686	1 310	589	958
Total profit increase (EUR/year)	6 767	12 147	6 520	2 288	3 212

*) Examples with freight revenue: 0.17 EUR/tonnes/km; 1.6 EUR/liter; and average trip distance (one-way): 15 km.

TABLE 1 B

Comparison of savings between Strenx® performance steel and other steels, in imperial units.

					
Chassis case	Light flatbed trailer chassis	Heavy flatbed trailer chassis	Curtain sider trailer chassis	Tipper trailer chassis	Lowbed trailer chassis
Tractor weight (lbs)	15 653	18 739	17 857	18 078	20 944
Trailer weight (lbs)	14 110	16 314	14 330	14 771	18 739
Total vehicle weight (lbs)	29 762	35 053	32 187	32 849	39 683
Maximum payload (lbs)	27 558	53 131	55 997	64 155	57 320
Gross vehicle weight (GVW) fully loaded (lbs)	57 320	88 185	88 185	97 003	97 003
Current chassis design					
Current material	S355	S235 Hot Rolled	S275	S355	S355 Hot Rolled
Chassi weight (lbs)	4 817	8 900	5 631	3 311	10 082
New chassis design					
New design material	Strenx® 110 XF	Strenx® 110 XF	Strenx® 110 XF	Strenx® 110 XF	Strenx® 110 XF
New design weight (lbs)	3 516	6 446	4 279	2 682	7 158
Savings with new design					
Savings (lbs)	1 301	2 047	1 351	629	2 924
Savings (%)	27%	23%	24%	19%	29%
Payload data with new design					
Total vehicle weight with new design (lbs)	28 462	33 006	30 836	32 220	36 760
Maximum payload with new design (lbs)	28 858	55 178	57 349	64 784	60 244
Distance with maximum load (%)	50%	50%	50%	50%	50%
Machine data					
Machine usage per year (miles)	62 137	62 137	62 137	43 496	12 427
Lifetime (years)	12	12	12	8	16
Fuel data					
Fuel consumption fully loaded (mpg)	6.7	4.5	4.9	3.5	3.1
Fuel consumption without loaded (mpg)	10.7	8.1	8.7	8.4	8.1
CO₂ lifetime savings					
Lifetime CO ₂ savings from less steel produced (tonnes CO ₂)	1.18	2.23	1.23	0.57	2.65
Lifetime CO ₂ savings from longer service life (tonnes CO ₂)	11.04	19.12	9.12	3.30	11.26
Lifetime CO₂ savings from higher capacity (tonnes CO₂)	28.39	41.32	20.36	5.55	17.47
Lifetime CO ₂ savings total (tonnes CO ₂)	40.62	62.66	30.71	9.41	31.39
CO ₂ payback time (months)	11,65	13,93	18,96	26,42	43,39
Lifetime fuel reduction (gallons)	3 473	5 322	2 596	779	2 530
If also using higher capacity in operation*					
Increased payload revenue (USD/year)	8 284	15 628	8 607	2 805	3 724
Fuel savings (USD/year)	926	1 419	692	311	506
Total profit increase (USD/year)	9 210	17 047	9 299	3 116	4 230

*) Examples with freight revenue: 0.41 USD/tons/mile; 3.2 USD/gallon; and average trip distance (one-way): 10 miles.

Design

Trailer designs are often the result of experience and knowledge gained by manufacturing companies over the years, as well as the know-how of end users. Good solutions are generally also applicable for lightweight vehicles produced in high-strength steel. However, high-strength steel enables new solutions, but may also require design changes in order to leverage its higher strength.



A typical trailer chassis consists of two longitudinal main beams manufactured from either standardized hot-rolled profiles or welded I-beams, along with a variety of cross-member profiles. Cross-members can be made from open profiles, tubes or box-section profiles, depending on trailer type. Floor members and different support profiles can also be attached to the chassis. The king-pin region of the trailer usually consists of a king-pin plate and some reinforcement profiles.

The potential for upgrading a trailer chassis is generally limited not only by its static load-carrying capacity, but even more so by fatigue and stability issues. Therefore, while finding a solution with matching load-carrying capacity

to the existing design serves as a good starting point, it is essential to address these other technical considerations in order to have a vehicle with matching or improved performance. It is important to note that poor design or production quality can rapidly reduce the vehicle life span.

The dimensioning load case for a trailer chassis manufactured from mild steel is generally its load-carrying capacity with regard to permanent deformations, as shown in Figure 3. In a lightweight trailer chassis, where thicknesses have been reduced and working stress levels increased, the load-carrying capacity and service life are limited by fatigue, elastic deflections and stability.

FIGURE 3

Trailers subjected to different loading situations during service.

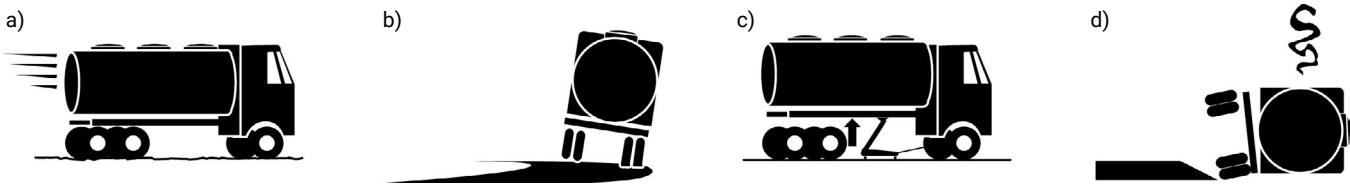

To achieve a successful upgrade, it is important to take all loading situations into account; a) Fatigue at frequent low-stress loading cycles, b) Elastic deformations when operating, c) Load-carrying capacity; no permanent deformations at maximum loading, d) Stability when operating.



Typical upgrades

Strenx® 700MC is commonly used in lightweight solutions for trailer chassis. Upgrading a trailer chassis from a S355 (grade 50) grade to Strenx® 700MC (Strenx® 110 XF) typically generates a weight reduction of about 30% for the chassis structural parts. However, depending on the chassis design, the weight reduction potential may be even higher, up to 50%. As an example, we have calculated the potential weight reduction of an existing 13.75-meter-long trailer main beam produced from a S355 (grade 50) steel grade by introducing Strenx® 700MC. The load-carrying capacity of the existing design has been determined and a matching alternative in Strenx® 700MC is suggested in Figure 4.

The total weight of the original main members manufactured from conventional steel is 1,085 kg, and the total weight of the upgraded alternative in Strenx® 700MC is 704 kg. This gives a weight reduction of 381 kg, or 35.2%. These results should be considered as an example.

Depending on the type of vehicle, specific requirements, and design details, the upgrading potential may be less or greater compared to our example. The calculations only consider static load-carrying capacity, but serve as a good starting point in developing a lightweight chassis design. The main beams of a conventionally designed trailer chassis have limitations in using a strength higher than Strenx® 700MC for structural strength. Exploring other chassis concepts is necessary to truly benefit from higher strength. For certain special trailers, however, higher grades like Strenx® 960 may make an appropriate choice. For flanges or profiles that are susceptible to wear or dents, such as the rear bumper, a higher strength steel like Strenx® 1100 or a wear-resistant steel like Hardox® 450 can be specified. For other parts of the chassis, such as floor members, cold-rolled steels like Strenx® 700 CR and Strenx® 960 CR offer significant weight reduction opportunities. These parts can be produced by bending and, for larger series, roll-forming or stamping.

FIGURE 4
Lightweight solutions for matching load-carrying capacity and bending stiffness.

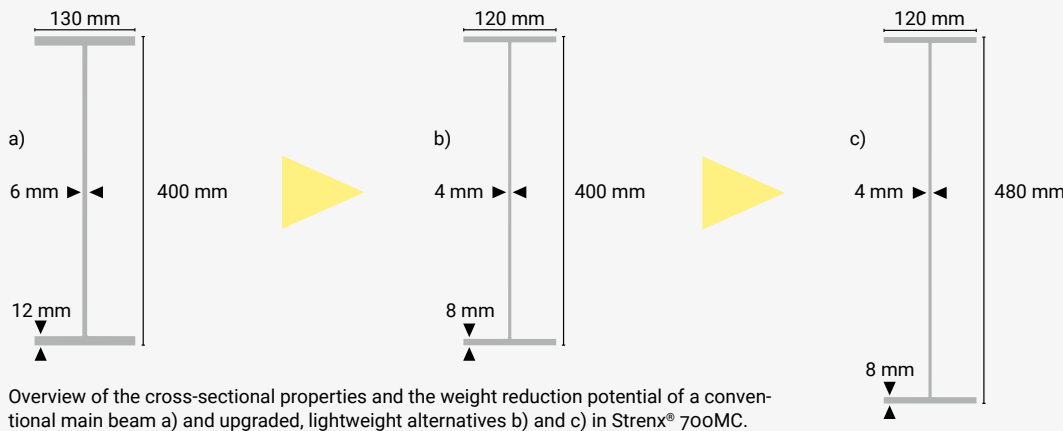

	a) Original design	b) Lightweight design	c) Lightweight design
Steel Grade	S355	Strenx® 700MC	Strenx® 700MC
Weight, m [kg/m]	42	27	29.5
Weight Reduction, [%]	–	36	30
Bending Moment Capacity, M [kNm]	286	306	369
Moment of Inertia, I [m⁴]	144 E-6	93 E-6 (-36%)	140 E-6 (-2%)
Section Modulus, W [m³]	72 E-5	44 E-5 (-39%)	53 E-5 (-27%)



Strenx®
700MC

Bending stiffness

Bending stiffness in the vertical direction is often cited as a critical aspect for lighter and stronger trailers in high-strength steel. In some markets, the elastic deflections of vehicles are regulated with regard to ground clearance, but in most cases, the limitations on deflections are a matter of functionality. That is, the deflections of the trailer chassis should not introduce problems in opening and closing doors. For certain special trailers, such as low-bed trailers, the requirements on the elastic deflections may limit the choice of material.

Since all steel grades have the same Young's modulus, the bending stiffness is determined by geometry. That is, simply reducing the sheet thickness of the consisting profiles will reduce the bending stiffness if the outer geometry remains the same. For a trailer chassis, the longitudinal beams determine the bending stiffness in the vertical direction. If the stiffness reduction is problematic, increasing the height of the cross-sections can improve the bending stiffness.

Increasing the height of the beam is the most efficient way to increase the bending stiffness. However, in areas where the height of the beam is restricted, the bending stiffness can be improved by increasing the flange width, as in Figure 5. This measure can also be taken in critical areas to reduce the working stress level and improve the stiffness in the lateral direction of the beams. Using modern manufacturing techniques, the flange width can be tailored over the length of the beam according to the load distribution. However, the width can only be increased to a certain degree because the thickness of the flange is reduced. The flange on the compressed side can become too slender and local buckling may occur. This will limit the material utilization of the flange. If the existing trailer beam is already very high, shear buckling of the slender web may limit the possibility to increase the height and reduce the thickness of the web. More information on instability and calculation methods are found in the SSAB Design Handbook.

Stability

The stability of an entire vehicle while riding on the roads or, in the case of tipper trailers, during unloading, depends on various factors, of which the torsional stiffness of the chassis is one. For tipper trailers and other trailers where significant twisting loads are present, this must be taken into account when upgrading the trailer chassis. The torsional stiffness of a chassis is determined by the design and position of the cross-members and the presence of cross-ties. Reducing the web thickness of the chassis main beams will have a very limited effect, while reducing the cross-member thickness will affect the chassis torsional stiffness significantly. To avoid stability issues, design changes can be introduced to achieve matching or even improved torsional stiffness compared to the original design.

By introducing profiles with closed cross-sections for the cross-members, the stiffness in torsion is significantly improved, as in Figure 6. However, for optimum material utilization, the position of the cross-members is equally important. The redistribution or introduction of one or two additional cross-members influences the overall torsional stiffness. In general, the cross-members should be focused towards the rear part of the chassis. However, this shift has been exaggerated in practice many times. By moving cross-members forward or introducing an additional cross-member in a strategic region of the front part, the overall behavior can be significantly improved. Since a small rotation in the front part results in big displacements of the rear, increasing the torsional stiffness of the front could improve the overall performance.

Introducing cross-ties is another effective measure. To ensure optimum material utilization, it is important to design the cross-tie to only carry tensile loading in one bar and allow the other bar to buckle. Therefore, the bars should be slender and not welded to each other at the center. To demonstrate the effect of these measures, a comparison was made of the twisting angle resulting from a torsional moment applied at the rear of a common tipper chassis. The results from the calculations represent a unique case, but clearly illustrate the impact of these measures on the

chassis stiffness in torsion. In all calculated cases, the total mass of the cross-members remained constant. That is, for the case where closed cross-sections were used, the thickness of the profiles was reduced. The

results show that a reduction in web thickness results in a minor decrease in torsional stiffness compared to the original design, while introducing closed cross-members or a double cross-tie significantly improves the stiffness.

FIGURE 5

Variable flange width can be introduced to improve the bending resistance and the bending stiffness in critical areas.



FIGURE 6

Comparison of the torsional resistance of a trailer chassis with open section cross-members to solutions with closed cross-member profiles and cross-bars.

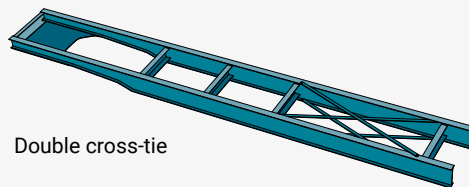
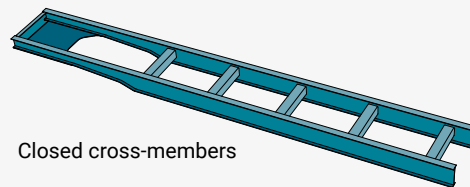
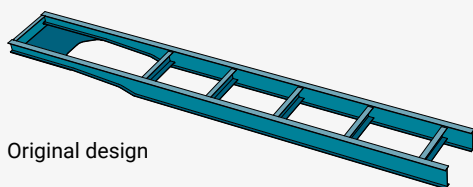
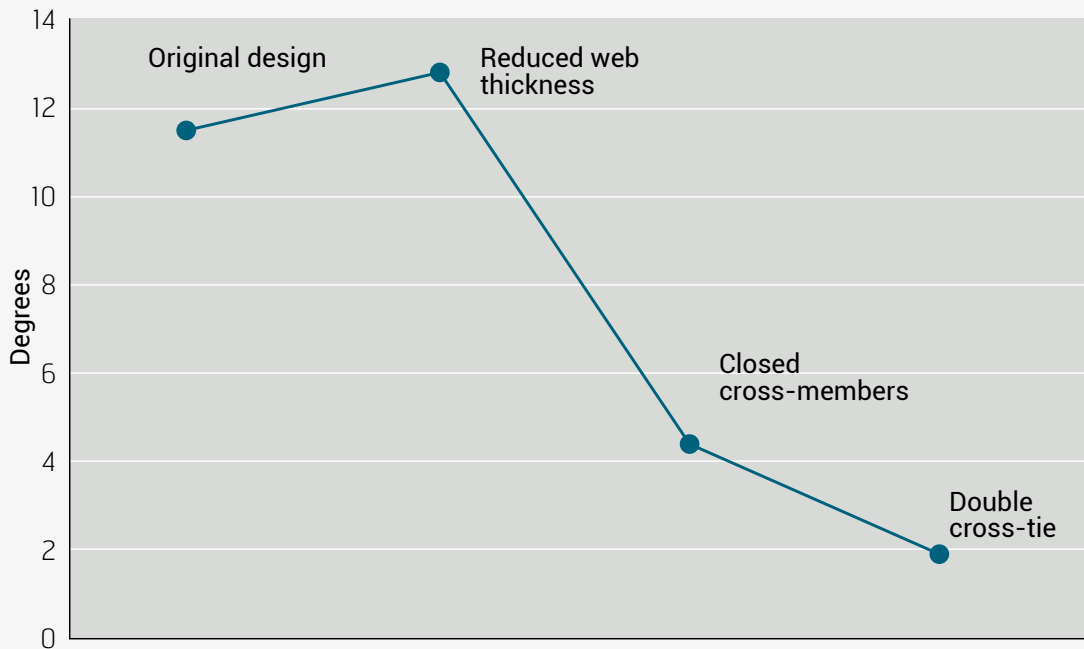

Fatigue

All trailers are subject to fatigue loads during driving and loading. The life of a trailer chassis is determined by the load history, which consists of collected loads of varying number and magnitude. The appearance of the load history will vary depending on the type of trailer, road conditions, and loading situation. When upgrading a trailer chassis using HSS, the sheet thickness of the structural parts is usually reduced. This reduction in thickness will result in an increased working stress level in the complete chassis. However, a stronger material will result in higher fatigue strength for the base material. For welded joints, this influence is limited due to the stress concentration and the initial imperfections introduced at the welds. Therefore, the fatigue life of welded joints is more dependent on design and manufacturing rather than choice of material. If the same weld joint design and weld quality are deployed, this will result in reduced fatigue resistance for the chassis.

Fatigue resistance

The fatigue resistance of a material is demonstrated in S/N curves, which are created by testing specimens using a load history of constant amplitude. This means that a specimen is subjected to the same load cycle repeatedly until it fails. After testing several specimens at different load levels, an S/N curve can be plotted. In Figure 7, the upper curves show that the fatigue resistance is determined by the static properties of the material. In the lower right part of Figure 7, the fatigue resistance is determined by discontinuities in the specimen. Discontinuities can

include surface texture from rolling of the sheet, cut edges, holes, notches- and welds. These are listed in order of decreased fatigue resistance.

Why is the welded joint a critical area?

Welded joints have a much lower fatigue resistance compared to the base material due to the sharp geometry of the weld and residual stresses introduced from the heat input during welding. While the fatigue resistance of welds is often discussed in relation to microstructures, heat affected zones, and hardness, the major cause of the weakening of the weld is local stress concentration and defects. All post-treatment methods of welds aim to reduce residual stresses and improve the weld geometry. To achieve good fatigue resistance, it is important to have a smooth transition radius and angle at the weld toe, as shown in Figure 8.

Start and stop positions

The start and stop positions of a weld are the most critical to its fatigue resistance. Since the welding process is not in a steady state, defects and inclusions are more likely to occur in these positions. Therefore, due to their limited length, tack welds have lower fatigue resistance than continuous welds. Tack welding of longitudinal beams should be minimized, and tack welds should be positioned in low-stress areas. The weld between the upper flange and the web is less sensitive to fatigue, since this area is mainly subjected to compressive stresses. It is important to design welded joints in general to allow the start and

FIGURE 7
S/N curves for specimens of rolled sheet, with punched hole and welded joint.

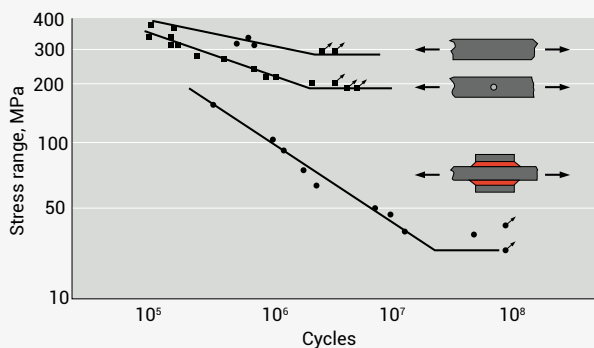

FIGURE 8
Sharp and smooth weld toe geometry.



stop of the weld to be placed in low-stress areas. In some cases, fish-tail design can be used to move the start and stop positions away from the most highly stressed area, such as at the end of a reinforcement plate (Figure 9).

Transverse versus longitudinal fatigue loading of a weld

Discontinuities in a weld are oriented in the welding direction and follow the root and weld toes. If the discontinuities are parallel to the principal stress direction, they have a small impact on the fatigue resistance of the weld. On the other hand, if the stresses are transverse to the weld direction, the fatigue resistance of the weld will be very low. For example, the fatigue life of an attachment bracket welded to the lower flange has less than 5% of the fatigue life of the weld between the web and the flange.

Load history

The load history of trailers is irregular and random by nature, and the total number of load cycles during its life is in the region of 10^8 – 10^9 cycles. Even if the majority of load cycles have a very small magnitude, they can still be potentially critical for fatigue when combined with larger loads, which can be perceived as crack initiators. On the other hand, small loads can be viewed as crack propagators. Due to these combined effects, the fatigue limit found in constant amplitude loading vanishes in trailer applications. The only exception is when all loads in the complete history are lower than the fatigue limit. Therefore, it is important that welds in high-stress areas have good fatigue

resistance, such as welds loaded in the lengthwise direction. Welds with less fatigue resistance should be placed in low-stress areas, such as near the neutral layer of the web of the main beams.

As an example, we can make a comparison of an alternative design for an attachment bracket welded to a beam that is subjected to bending in the vertical direction. When loaded in global bending, the maximum stresses occur at the flanges of the beam and vary in compression and tension over the neutral layer. The design at the top (a) in Figure 10 has the attachment bracket welded near the flanges, with the start and stop positions of the weld located in the most highly stressed area of the beam cross-section. The configuration at the bottom (b) in Figure 10 has the attachment bracket redesigned to be plug welded closer to the neutral layer. This results in the stress level at the welded joint being reduced by 50%, which increases the fatigue life 8 times compared to the previous design.

Common pitfalls

When upgrading from conventional steel to HSS in order to develop a lightweight solution, there are some common pitfalls that can be avoided by implementing simple measures. The first and most important design advice is to keep the structure simple. Reduce the number of parts and utilize modern manufacturing techniques to integrate attachments and minimize the number of welded joints.

FIGURE 9

Fish-tail design can be introduced to move the start and stop positions of a weld away from a high-stress area.

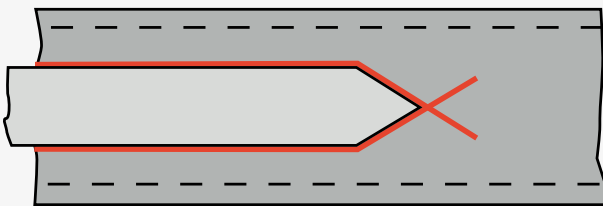
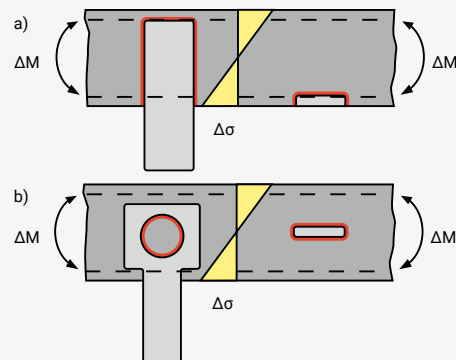

FIGURE 10

By redesigning the welded joints to be placed in low-stress areas the fatigue life will be improved.



For the chassis main beams, we recommend that you use a single piece for the flanges and the web throughout the full length of the trailer. This solution reduces the number of welds, especially in the transverse direction, which is important from a fatigue point of view.

Reinforcement plates are frequently used on both webs and flanges to increase the load-carrying capacity and stiffness of the chassis. While this measure can be beneficial from a static perspective, it can do more harm than good from a fatigue perspective.

In a main beam, manufactured from single pieces along the length without any reinforcement plates, the longitudinal weld of the I-beam will determine the fatigue life. When the trailer is loaded, the lower flange will be subjected to tensile stresses in the lengthwise direction in line with the weld. If a reinforcement plate is welded to the lower flange, there will be a transverse loading of the welded joint that reduces fatigue life by at least 8 times (Figure 11). Introducing a reinforcement plate to the web or the flange also creates a stress concentration

at the welded joint, since there will be a stiffness gradient in this area. Therefore, this weld joint will limit the fatigue life of the chassis and may cause cracking problems in an upgraded design where the working stress level is higher.

Landing gear attachment

One of the most critical areas on a trailer chassis is the goose neck region. The height transition results in high stresses, which do not generally affect the trailer's static load-carrying capacity. However, extra care is needed when designing secondary structures, such as the landing gear attachment, in this area.

If the landing gear attachment is designed to be welded to the flanges, the weld joint will be in the most highly stressed area of the beam cross-section. Redesigning the attachment bracket to be attached to the web instead moves the weld joint into an area with lower stresses (Figure 12). This will improve the fatigue life of the weld joint substantially (Example A).

FIGURE 11

Reinforcement plates welded to the lower flange will rapidly reduce the fatigue life.



FIGURE 12

To improve fatigue life of the landing gear the attachment should be placed close to the neutral layer of the main beam. A bolted connection will improve the fatigue

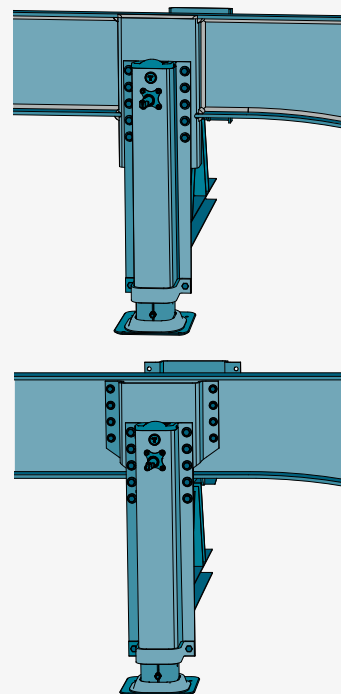

Example - A

It is common to design the landing gear in a conventional trailer chassis to be welded to a reinforcement plate that is attached to the lower flange in the neck region of the trailer, as in Figure 13. This weld is placed in a critical region from a fatigue perspective. When developing a lightweight trailer chassis and reducing the thicknesses, the working stress level will be higher. This will result in a reduced fatigue life for this weld if no redesign is performed. This example demonstrates how a redesign of the attachment bracket affects the fatigue life.

The calculations are performed on a conventional main beam manufactured from mild steel (a) and an upgraded alternative in HSS (b) according to Figure 14. The fatigue life of this weld in the conventional trailer chassis is assumed to be 16 years. The upgraded design assumes that the attachment bracket is welded directly onto the lower flange, without a reinforcement plate. The nominal stress due to bending of a beam is given by

$$\sigma = \frac{M_b}{W}$$

The second moment of inertia, I , and the section modulus, W , are determined by using Steiner's theorem or CAD software. As such, the stress at the weld in both alternatives can be determined according to

$$\sigma_b = \frac{M_b}{W_b}, \quad \sigma_a = \frac{M_b}{W_a} \quad \sigma_b = \frac{\sigma_a W_a}{W_b} = \frac{\sigma_a \cdot 685\,000}{348\,000} = \sigma_a \cdot 2$$

This shows that the stress level at the critical weld is 100 MPa in the conventional chassis. It will be $100 \cdot 2 = 200$ MPa in the upgraded trailer. The fatigue life of a weld is related to the applied stress range by a power of 3; hence the fatigue life of the critical weld in the upgraded trailer will be reduced by

$$\left(\frac{\sigma_b}{\sigma_a}\right)^3 = 2^3 = 8$$

That is, the fatigue life of the critical weld in the upgraded design will be reduced from 16 years to $\frac{16}{8} = 2$ years!

If the welded joint is redesigned according to Figure 10 in the previous section, and the critical weld joint is removed, the longitudinal weld between the flange and the web becomes the dimensioning factor from a fatigue perspective. The strength of a longitudinal weld is much higher than the transverse weld. If we compare the fatigue strength of these welds, we find that the critical weld at the attach-

ment has a characteristic fatigue strength, FAT, of 63MPa but the longitudinal has a FAT of 125 MPa, as in Figure 15. This means that the longitudinal weld can tolerate twice the stress compared to the transverse weld.

So even though the working stresses have been increased by a factor of 2 in the upgraded I-beam, the fatigue strength of the critical weld joint has been improved by a factor of 2 through a simple redesign. Hence, we have maintained the fatigue life of the original design.

FIGURE 13

Landing gear attachment welded to the reinforced lower flange of a conventional trailer main beam.

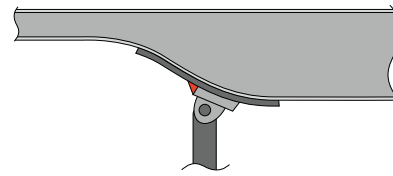
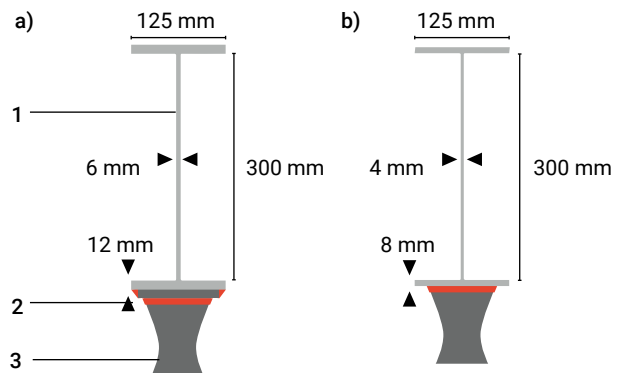

FIGURE 14

Geometry and cross-sectional properties of the conventional a) and upgraded main beams b) included in the calculations.



Moment of inertia: $I_a = 87E-06 \text{ m}^4$, $I_b = 52E-06 \text{ m}^4$
 Section modulus: $W_a = 685E-06 \text{ m}^3$, $W_b = 348E-06 \text{ m}^3$

1. Main beam
2. Reinforcement plate
3. Landing gear attachment

FIGURE 15

Characteristic fatigue strength (FAT) of welded joints subjected to transverse a) and longitudinal b) loading

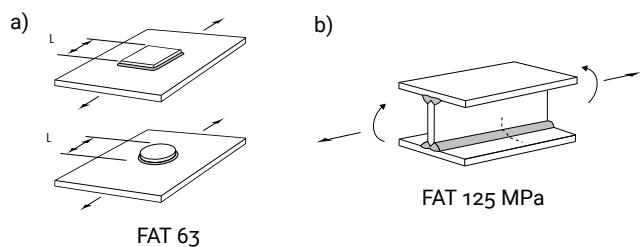

First rear axle attachment

As for the goose neck area, the hanger bracket region is a critical area on a trailer. Apart from vertical bending, lateral loads will be introduced in this area. It is therefore important to avoid welding at the edge of the flanges, since these are high-stress areas.

To reduce the stiffness gradient between the hanger bracket and the lower flange, it is beneficial to weld the bracket to an attachment plate. The plate must have sufficient thickness, and the welds between the plate and the flange must be positioned at least 20 mm from the edge of the flange. Variable flange width can be introduced to increase the bending moment capacity and the area available for attaching the hanger brackets. To further improve the fatigue life, the hanger bracket attachment can be designed as a bolted joint, as in Figure 16.

Any web stiffeners used to manage the local vertical shear loads in this region should be positioned in line with the loading direction from the hanger brackets. Placing the stiffener at a distance from the hanger bracket will introduce an additional bending of the lower flange and reduce the fatigue life significantly.

Cross-member attachment

For trailer chassis that are subjected to torsional loading, such as tipper or dump trailers and timber trucks, we strongly recommend using profiles with a closed cross-section for the cross-members. In most cases, this solution enables the cross-members to be welded straight into the web without any additional reinforcements. For heavy-duty vehicles, a web stiffener can be integrated in the cross-member attachment to increase stiffness and reduce stress levels in this area, as in Figure 17.

Profiles with open cross-sections can be used in trailers whose cross-members are mainly subjected to bending, e.g. curtain-siders, container carriers, and vans. Openings for every profile can be cut into the web, and the profiles can be welded to the web plate of the longitudinal beam. However, it should be noted, that profiles with open cross-sections are not recommended for chassis subjected to twisting loads.

Yet another solution is to use an attachment bracket to distribute the stresses over a larger area. The attachment bracket can be welded, riveted or bolted to the web of the longitudinal beam.

Rear underrun protection devices

Rear underrun protection devices (RUPDs) significantly enhance the safety of car occupants during collisions with heavy vehicles. The most recent RUPD standard mandates a substantially stronger structure than its predecessors, making high-strength steel tubes the ideal choice for this purpose.

By incorporating Strenx® 700 and Strenx® 960 steels in the main cross beams and support legs, the structure achieves the required strength while maintaining a reasonable weight limit. The SSAB tubes portfolio offers a variety of high-strength steel tube dimensions in rectangular, square, or circular shapes. All are specifically engineered to meet the RUPD standard requirements.

It is important to note that RUPD performance depends on the overall behavior of the structure, not only the cross-beam. Consequently, the connection between the cross-beam and support legs, the support legs themselves, and the connection between the support legs and the chassis should be considered carefully during the design stage.

While the RUPD structure might possess adequate strength to endure the specified loads, the primary beam of the chassis could experience failure. To address this issue, reinforcing the chassis main beam through the incorporation of local stiffeners or employing higher grades of steel in the chassis can provide effective solutions.

Adding extra stiffener to strengthen the structure where the crossbeam connects to the support legs can effectively prevent or delay local buckling of the crossbeam and improve the load-carrying capacity of the RUPD. On the downside, this solution might allow stones or dirt to gather. Adjusting the stiffener by tilting it downward can fix the problem.

FIGURE 16

Placing the web stiffener at a distance from the hanger bracket introduces additional bending to the lower flange, which will rapidly reduce fatigue life.

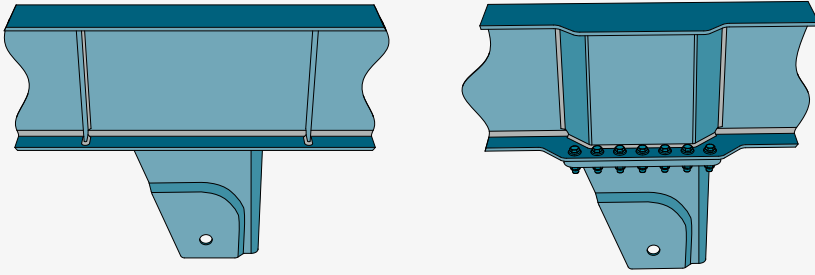

To improve the fatigue properties, any web stiffener in this region should be positioned directly in line with the hanger bracket. Introducing a wider flange increases the resistance to side bending and enables the welds to be placed at a distance from the critical area at the lower flange. To improve the fatigue life even further, a bolted joint could be introduced.

FIGURE 17

Different types of cross-member attachments.

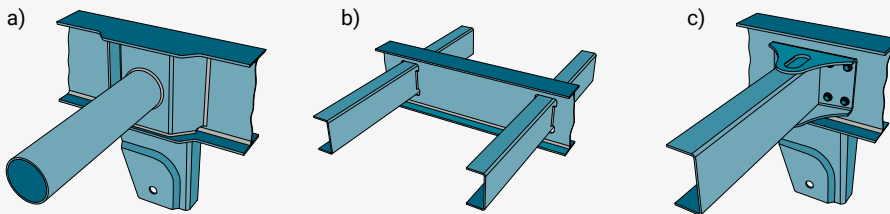

The type of cross-member to be used and the design of the attachment to the main beams depend on the type of trailer. For trailers subjected to substantial twisting loads, closed cross-member profiles are recommended. For heavy-duty vehicles, it is beneficial to combine such a profile with a U-shaped web stiffener welded to both the flanges and the web (a). Welding of protruding C-profile cross-members can be limited to the web of the profile (b). Cross-members can also be bolted or riveted to the main beams.

FIGURE 18

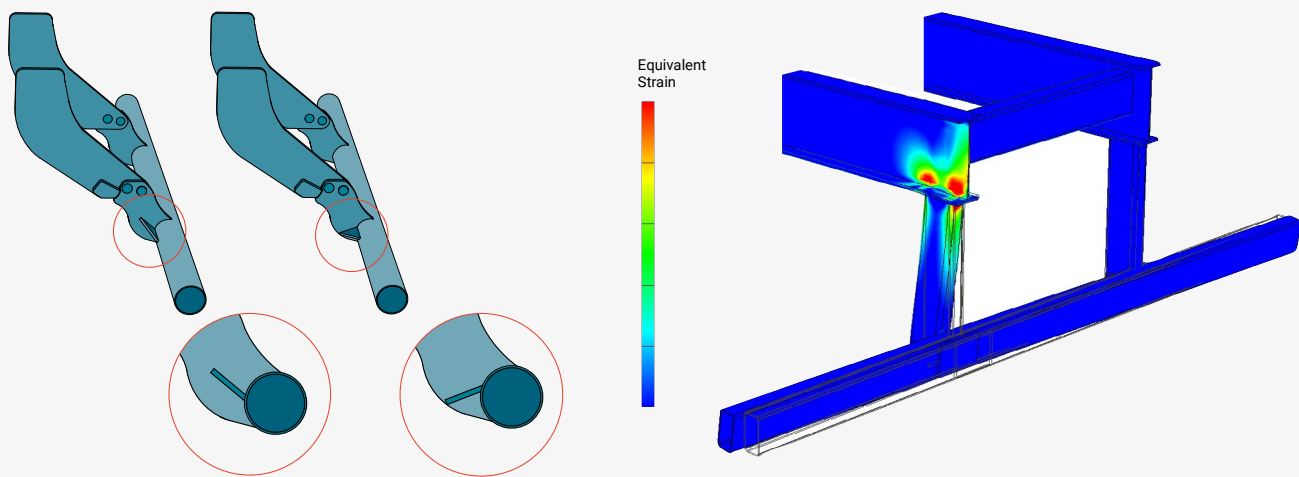

Manufacturing

Our experience has shown that the primary cause of fatigue failures in trailer chassis is poor weld quality. Therefore, it is vital to not only thoroughly evaluate the new upgraded design, but to secure the production process. Poor weld or edge quality will rapidly decrease the service life of any trailer.



Edge quality

Edge quality also impacts fatigue resistance, and different cutting methods result in different edge qualities. Figure 18 shows the results of fatigue testing Strenx® 700MC where the plate edge has been milled, laser-cut and sheared. Laser-cut edges are often better than mechanically cut edges. To achieve good fatigue strength with mechanically cut edges, it is important to remove all visual crack-like defects. Modern thermal cutting processes like laser or high definition plasma generally produce edges in Strenx® 700MC with good fatigue properties. The ranking of such methods from a fatigue perspective would be laser, plasma and gas-cutting. To avoid fatigue problems, it is also important to place start and stop positions in low-stress areas. Blasting of a structure with cut edges normally has a positive effect on fatigue resistance.

Typical welding methods

All conventional welding methods can be used for HSS. The most commonly used welding methods in the trailer industry today are:

- MAG welding (with solid or cored wire)
- Submerged arc welding (sometimes used to produce longitudinal beams)

Filler metal

The strength of the filler material should normally be matched to the strength of the base material, as in Table 3. However, welds in trailer applications are rarely subjected to stress levels that require matching filler metal. In most cases, it is therefore possible to use undermatching filler metals. If submerged arc welding is used for welding HSS, basic flux is recommended.

FIGURE 18
Results from fatigue testing Strenx® 700MC with different edge conditions.

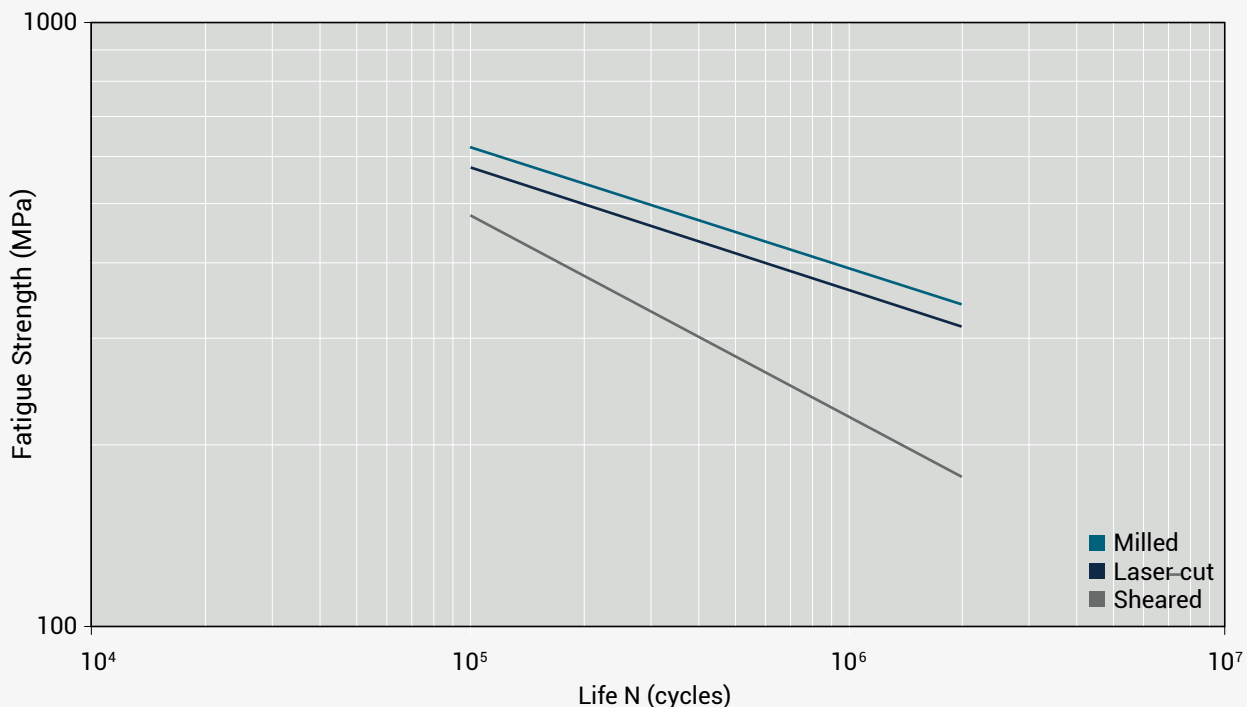

Heat input

High-strength steels are somewhat sensitive to high heat inputs. Excessively high heat input decreases the strength as well as the impact toughness of the welded joint. If the minimum yield strength of the base material must be achieved in the welded joint, the maximum recommended heat input should not exceed the values in Figure 19.

The graph in Figure 19 is valid for butt welds, welded with matching filler metal, and where the reinforcement has been removed before testing. The maximum interpass temperature is 100 °C. The heat input can be calculated according to Figure 20.

The arc efficiency values for SAW and MAG-welding are given in Table 4.

If the weld is located in a low-stressed area and the impact toughness requirement is of minor importance, higher heat inputs can be used.

FIGURE 19

Maximum recommended heat input (Q) for Strenx® 700MC.

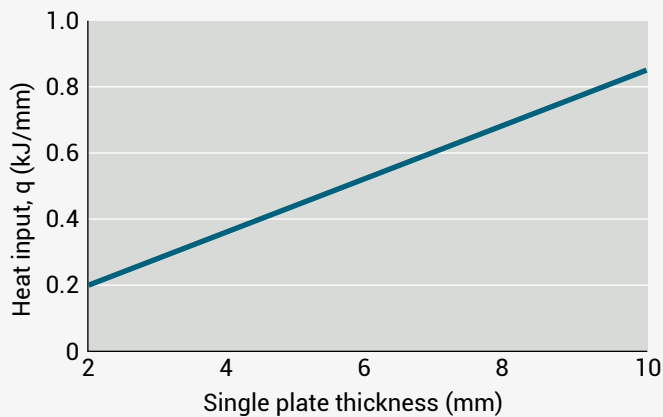

Maximum recommended heat input in order to fulfill the minimum yield strength (Re) and impact toughness requirements at -40 °C.

FIGURE 20

Formula used for calculating the heat input.

$$E = \frac{U \cdot I \cdot 60}{v \cdot 1000} \text{ kJ/mm} \quad Q = E \cdot k$$

U = Voltage, I = Current, v = Travel speed (mm/min),
k = Arc efficiency.

Heat input – Strenx® cold-rolled high-strength structural steel (CR)

Strenx® CR is produced in thinner gauges, making it more difficult to increase the heat power enough to limit the heat affected zone to a level that will allow for a failure of the base material. As a rule of thumb: weld with as low a heat input as possible.

Distortion

In practice, for trailer applications, distortion due to welding is more critical than the static strength of the welds. Follow these tips to minimize the amount of distortion due to the welding operation:

- Weld with as low a heat input as possible.
- Minimize the cross-sectional area of the weld, as in Figure 21.
- Prebend, clamp or angle the parts before welding in order to compensate for the shrinking.

FIGURE 21

Cross-section of the weld and how it influences the angle deviation.

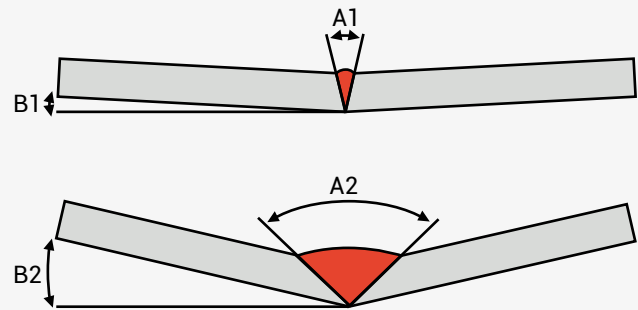
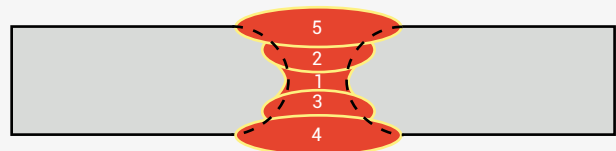

FIGURE 22

Use a symmetrical welding sequence.



- Avoid irregular gaps in the root.
- Use symmetrical welds, as in Figure 22.
- Minimize reinforcements and optimize the throat thickness of the fillet welds.
- Weld from rigid areas to loose ends.
- Optimize the welding sequence.

To avoid a curved or deformed longitudinal beam after welding of the web, displace the web in relation to the center of the flange. This makes it possible to locate the longitudinal welds in the neutral layer of the flanges, as in Figure 23.

Distortion – Strenx® CR

In order to avoid heavy deformation of Strenx® CR steels, follow these guidelines:

- Weld with as a low heat input as possible.
- Use a wire with a small diameter (0.8 mm).
- Downhill welding technique reduces the heat input and

is recommended if permitted by the application and the production conditions.

- If the application allows a small gap between the welds, intermittent welding can be used.
- If the application requires a sealed connection, silicon or adhesives could be used instead of welding to seal the connection and prevent corrosion to arise.
- Use lap welds instead of butt welds.
- Welding of thin sheets requires a short distance between the tack welds (80–120 mm).
- Power sources for MAG welding have greatly evolved, making it possible to weld thin sheets with approximately 50% lower heat input.
- If the joint is accessible from both sides, resistance spot welding can be used instead of fusion welding.
- Avoid welding and use mechanical joining, which ensures very low or no deformation.

TABLE 3

Filler material for Strenx® performance steel.

Steel Grade	MAG Welding (GMAW)	Submerged Arc Welding (SAW)
Strenx® 700MC	AWS: A5.28 ER100S-X AWS: A5.28 ER110S-X EN 12534: G Mn3Ni1CrMo EN 12543: G Mn4Ni2CrMo	AWS: A5.23 F10X AWS: A5.23 F11X EN ISO 26304-A S69X
Strenx® 700 CR	AWS: A5.28 ER110S-X	
Strenx® 960 CR	AWS: A5.28 ER120S-X EN 12534: G Mn3Ni1CrMo EN 12543: G Mn4Ni2CrMo	

TABLE 4

Arc efficiency for different welding methods.

Welding method	Arc efficiency
MAG-welding	0.8
SAW	1.0

FIGURE 23

Displacing the web in relation to the flange makes it possible to weld in the neutral layer of the flange, which avoids deformations from welding.

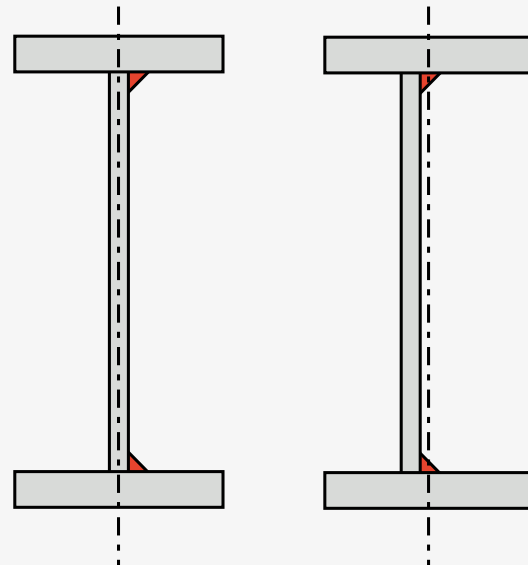



Straightening

Hot straightening is a very common method to restore longitudinal beams for trailer chassis that have been distorted due to welding. Hot straightening is not recommended for Strenx® and Strenx® CR. This is because the steel may lose its guaranteed properties in the heated area.

The recommended maximum temperature these steels can be subjected to without losing their guaranteed mechanical properties is:

Strenx® 700MC 650 °C

Strenx® 700 CR 300 °C

Strenx® 960 CR 200 °C

Weld quality

If the flanges of the longitudinal beam have to be welded (which is not recommended) in order to increase the length of the flange or beam, use a temporary sacrificial plate for critical weld starts and stops. The temporary plate can easily be removed by grinding after welding. See Figure 24.

Grind the edge with a smooth grinding wheel and make sure that the direction of the grinding scratches is longitudinal to the loading direction, as in Figure 25.

Another alternative is to design the weld joint at a 45 degree angle to the length of the flange in order to avoid a principal stress flow in the transverse direction of the weld.

Welding with rutile cored wires has the tendency to create very smooth transitions between the weld metal and the base material. This property could be used in order to increase the fatigue performance of the weld, especially in critical areas like the landing gear attachment and the hanger bracket attachments.

To secure the weld quality, it is important to examine all welds. Defects that are especially detrimental for the fatigue performance of the trailer are surface-breaking weld defects such as:

- Undercuts
- Root defects
- Lack of fusion
- Cold laps
- All types of cracks

With a proper welding technique and understanding of how these defects occur, it is possible to avoid unnecessary repairing. Figure 26 a-f) describe the most common weld discontinuities, their cause and actions to avoid them.

FIGURE 24

Pay attention to the stops, which are placed on the sacrificial plate. This plate is then removed by grinding.



FIGURE 25

Proper direction of the grinding scratches oriented longitudinal to the stress.



FIGURE 26

Welding defects, their cause and actions to avoid them: a) Lack of penetration b) Undercut c) Lack of fusion d) Pipe e) Porosity f) Sagging.

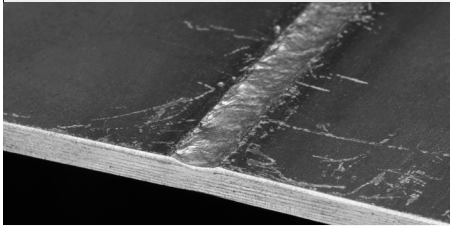

Sagging (weld concavity)

Cause

- Too high travel speed
- Too few beads
- Vertical down welding position

Remedial actions

- Reduce the travel speed
- Use sufficient number of beads
- If feasible, switch to another welding position than downhill welding

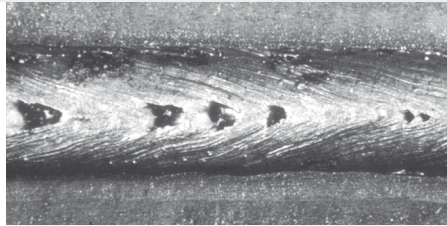
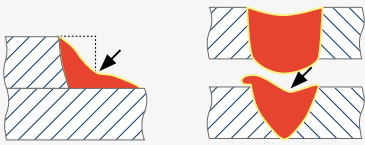

Porosity

Cause

- Impurities in the joint (moisture, oil, corrosion, etc)
- Disturbing breeze
- Too high gas flow
- Too low gas flow
- Shielding gas contaminated (equipment)
- Surface coating (zinc, primer)

Remedial actions

- Keep the joint free from any impurities
- Check the equipment
- Control the gas flow
- Welding technique (torch angle)
- Remove surface coating

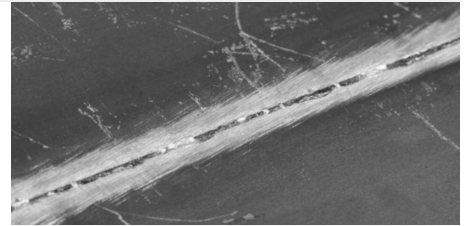

Lack of penetration/root defect

Cause

- Too small joint angle
- Too small gap
- Too large root face
- Wrong welding technique
- Too low heat input

Remedial actions

- Increase the joint angle (45–60°)
- Increase the gap
- Adapt the root face in relation to the heat input (1–2 mm/ 0.039–0.079")
- Decrease the oscillation of the electrode
- Increase the heat input

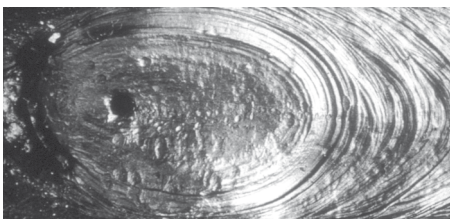
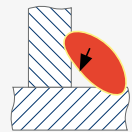

Pipe

Cause

- Wrong welding technique

Remedial actions

- Use a proper welding technique. Reverse and re-ignite to fill up the crater. Larger beads/cross sections might require a short cooling time (2–3 s) before the crater is filled.
- Add small stop plates at the end of the joint

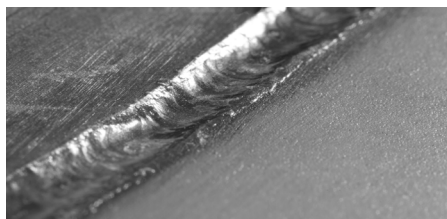
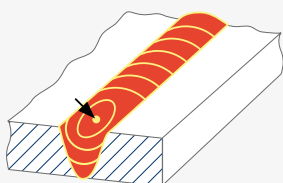

Root concavity

Cause

- Wrong welding technique in position welding
- Too large root face

Remedial actions

- Adjust torch angle and reduce the heat input
- Use a root face of max 1.5–2 mm (0.059–0.079")

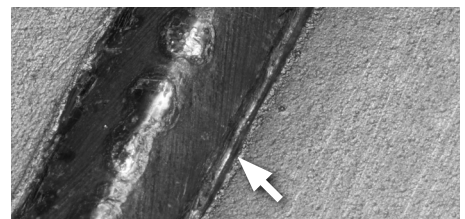

Incompletely filled groove

Cause

- Too high travel speed
- Too few beads
- Misplaced weld bead

Remedial actions

- Reduce the travel speed
- Use sufficient number of beads
- Make sure that the weld bead covers the groove



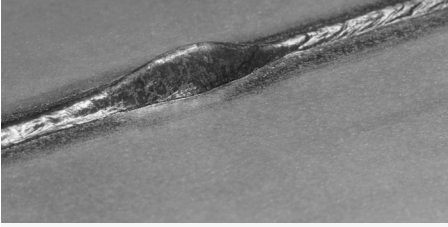

Excessive penetration

Cause

- Too large gap
- Too small root face
- Too high heat input
- Wrong welding technique

Remedial actions

- Decrease the root gap
- Increase the root face
- Decrease the heat input
- Increase the oscillation of the electrode

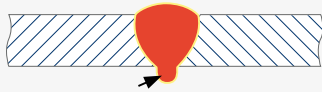

Undercut

Cause

- Too high travel speed
- Incorrect oscillation technique
- Incorrect torch angle
- Too high voltage
- Too high heat input

Remedial actions

- Decrease the travel speed
- Use small stops at the end of oscillation
- Neutral or a small forehand angle is beneficial
- Decrease the voltage
- Reduce the heat input

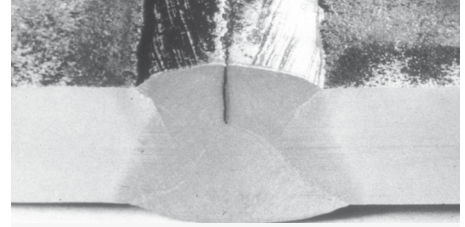
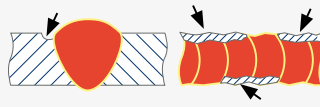

Hot crack/ solidification crack

Cause

- Weld bead too deep relative to the width
- High C, S, P, Nb pick-up
- Too high travel speed
- Large root gap

Remedial actions

- Make sure that the width/depth ratio of the weld exceeds about 1.0
- The joint must be free from impurities
- Reduce the welding speed
- Reduce the root gap

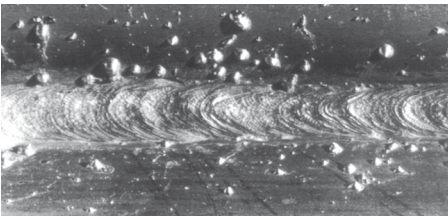
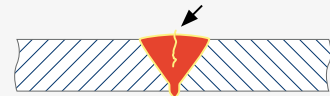

Spatter

Cause

- Too high voltage relative to the wire feed speed
- Surface impurities
- Magnetic arc blow
- Coating (primer, zinc)

Remedial actions

- Decrease the voltage level
- Make sure that the surface is free from impurities
- Weld towards the ground clamp
- Grind away the surface coating

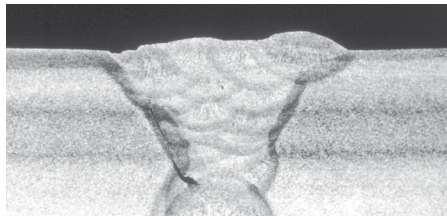
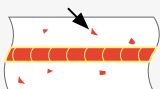

Lack of fusion

Cause

- Travel speed too low (weld metal starts to flow in front of the arc)
- Travel speed too high
- Arc voltage too low
- Too long stick-out distance
- Contact tip worn out
- Insufficient inter-run cleaning
- Vertical down welding position

Remedial actions

- Increase the travel speed
- Decrease the travel speed
- Increase the arc voltage
- Decrease the stick-out distance
- Replace the contact tip
- Remove the surface slag prior to next run
- Adjust the travel speed relative to the position

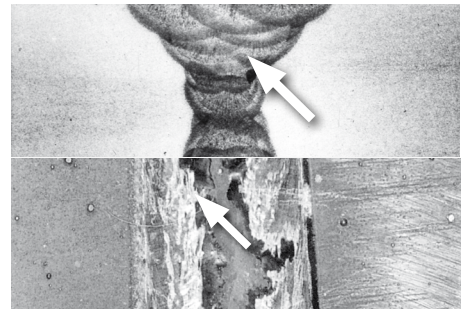

Slag formation

Cause

- Unstable welding conditions can cause an excessive amount of slag and an irregular weld surface, which makes slag removal more difficult
- Welding in downhill position
- Travel speed too low

Remedial actions

- Weld with parameters that support a stable arc
- Avoid welding in downhill position
- Increase the travel speed in order to make sure that the weld pool doesn't flow in front of the arc



Future-proof your business



The requirements for trailers are constantly evolving, with the three main goals being:

1. Greater trailer capacity
2. Lower lifetime cost
3. Lower carbon footprint

Although these goals may sound contradictory, less and more advanced steel can support them all. Together, they ensure that trailers are competitive, profitable and future-proof.

Greater trailer capacity

Regardless of whether the limiting capacity is maximum trailer weight or maximum volume, higher trailer capacity is defined by design.

To increase the load capacity, the trailer must be made lighter. To increase the volume capacity, the trailer chassis height can be lowered, assuming the maximum vehicle height is reached.

In both cases, the key is advanced design and advanced steel. For more than 30 years, SSAB has been providing technical support to customers who want to build advanced structural equipment made with yield strengths ranging from 700 to 1100 MPa.

New design aims to go beyond what others have done.

By challenging the traditional two-beam trailer solution with perpendicular profiles, it enables the design to follow and manage the stresses rather than isolate and concentrate them. A complete redesign is required to achieve the full effect. In addition to redesigning beams and cross-beams, it should include:

- Consideration of alternative production methods.
- Allowing for elastic movements.
- Using alternative joint methods to welding, such as bolting, riveting, clinching and bonding.
- Eliminating welded joints with forming or 3D-printing.
- Replacing welded joints.
- Post-treating welded joints.
- Avoiding instability of the steel members.
- Avoiding instability of the whole trailer.
- Avoiding fatigue.

Let SSAB show you how it can be done!

Lower lifetime costs

Efficient production methods are key to reducing lifetime costs. Less steel is used, which results in reduced weight, higher trailer capacity, and longer service life. Again, advanced design and advanced steel are required.

SSAB's high-strength steel is highly uniform and consistent. The plates have a very low variation in yield strength, high flatness and a very precise thickness. This results in consistent production conditions, both within a single steel plate and from plate to plate. This is essential for fully automatic laser-cutting machines, on-line geometry machine feedback, high-speed manufacturing with machine learning, robot production with 3D scanner feedback, and 3D robot forming. The technology is available for serial production. The most successful trailer producers will implement and improve this technology further.



The advanced design also reduces fatigue and results in a longer service life.

Lower carbon footprint

Eliminating CO₂ gas emissions is critical to slowing global warming. The electric, biofuel and low-emission trucks of the future will produce very low carbon emissions during operation.

The large lifetime emissions are caused by the embodied carbon footprint – the emissions from the extraction and transportation of raw materials in the truck and trailer. For a trailer, more than 70–90% of this footprint comes from steel.

To minimize your carbon footprint, there are three steps you can take:

- **Use better steel:** SSAB's blast furnace-based production is among the most CO₂-efficient in the world, reducing the carbon footprint of our own products as well as those of our customers. This gives both us and our customers a competitive advantage. On ssab.com, you can download our environmental product declarations (EPD).
- **Use steel better:** SSAB is the world leader in high-strength steel. Stronger steel saves weight. This means lighter trailers and stronger products, which in turn reduces the impact on the environment.
- **Go emission-free:** SSAB is the world's leading steel producer of emission-free steel. SSAB Zero™ is a steel made from recycled steel and produces largely zero carbon emissions during steel production, without mass allocation of emission reductions or carbon offsets. SSAB Fossil-Free™ steel is manufactured using revolutionary HYBRIT® technology, which replaces coal with hydrogen in the iron ore reduction process. The byproduct of this process is water instead of carbon dioxide. Find out more about how the groundbreaking technology was developed, how it works, the benefits of fossil-free SSAB steel and why it is a sustainable steel at www.fossilfreesteel.com.

SSAB is happy to support you in calculating your carbon footprint and be your discussion partner in developing a future-proof business.

FIGURE 27

Upgrading from standard steel to Strenx® high-strength steel enables new trailer designs with less steel in the chassis, higher payload, greater profitability and a longer service life (illustrative).

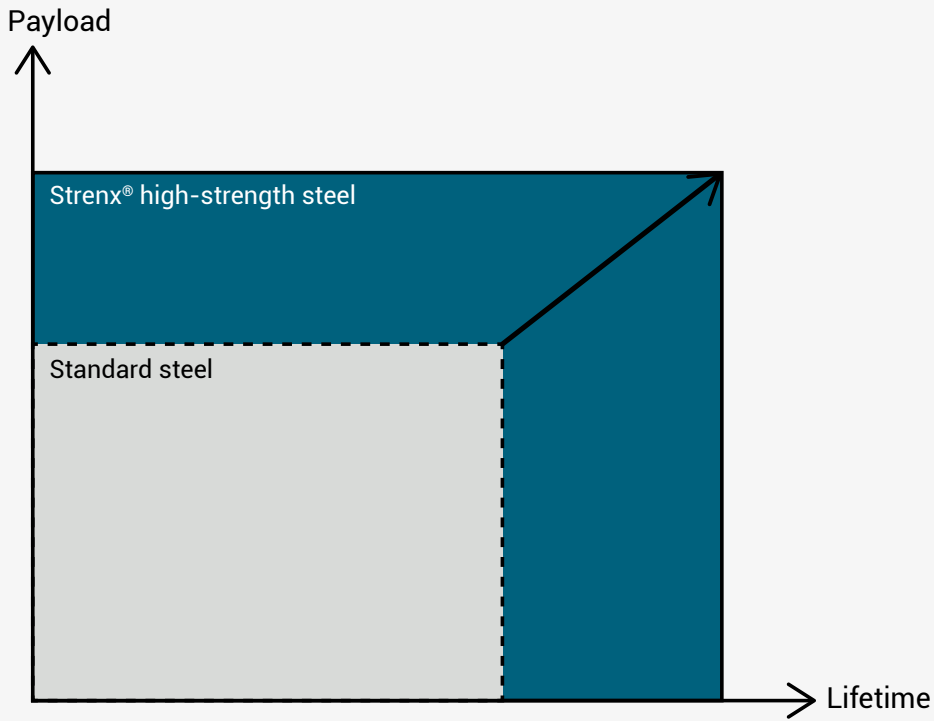
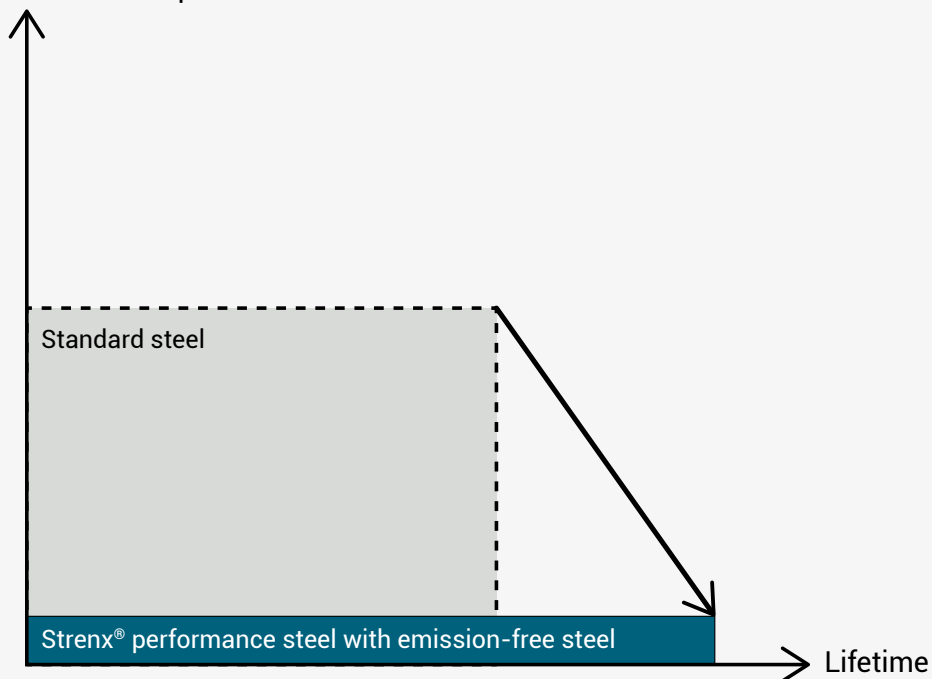

FIGURE 28

The steel material and production of the trailer are the predominant sources of carbon footprint. Upgrading from standard steel to Strenx® high-strength steel with SSAB Zero™ or SSAB Fossil-free™ steel enables a very low carbon footprint (illustrative).

Carbon footprint from material and production of a trailer



SSAB is a Nordic and US-based steel company. SSAB offers value-added products and services developed in close cooperation with its customers to create a stronger, lighter and more sustainable world. SSAB has employees in over 50 countries. SSAB has production facilities in Sweden, Finland and the US. SSAB is listed on Nasdaq Stockholm and has a secondary listing on Nasdaq Helsinki.

SSAB
P.O. Box 70
SE-101 21 Stockholm
SWEDEN

Visiting address:
Klarabergsviadukten 70

Telephone: +46 8 45 45 700
Email: contact@ssab.com

strenx.com

STRENX[®]
PERFORMANCE STEEL